

Article number: 2310431161

Description: E+G Levelling elements  
LX.30-SW17-SST-M8X33

## Measures

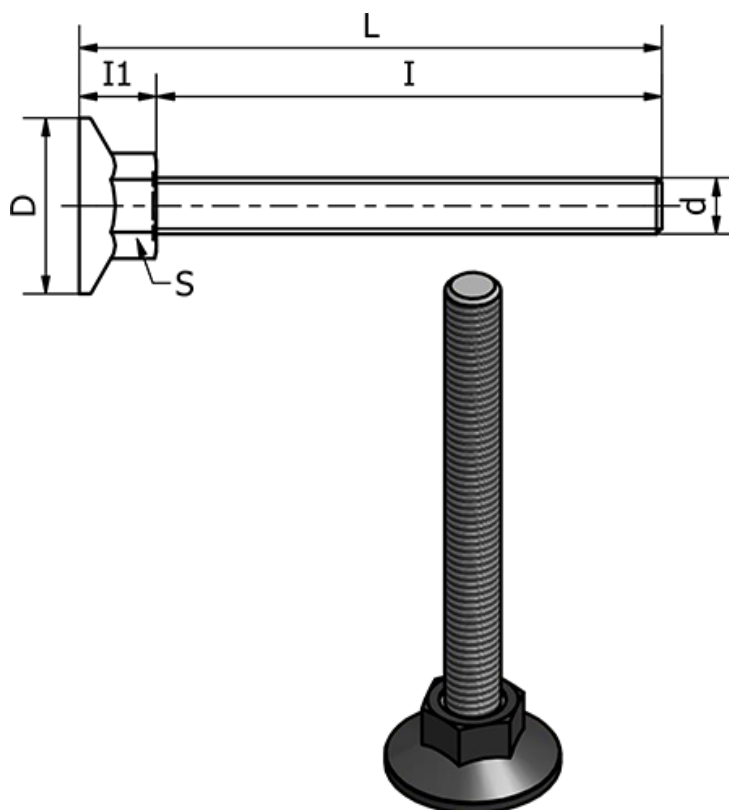

d = M8

D = 30

I = 33

I1 = 12

L = 43

S = 17

Static load in (N) = 2500

Type = AISI 304 Rustfast

Weight (g) = -